

Keysight 16060A Transformer Test Fixture

NOTICE: This document contains references to Agilent Technologies. Agilent's former Test and Measurement business has become Keysight Technologies. For more information, go to www.keysight.com.



Agilent 16060A Transformer Test Fixture
Operation and Service Manual



Agilent Technologies

Agilent Part No. 16060-90000
Printed in JAPAN March 2000

Notice

The information contained in this document is subject to change without notice.

This document contains proprietary information which is protected by copyright. All rights are reserved. No part of this document may be photocopied, reproduced, or translated to another language without the prior written consent of the Agilent Technologies.

Agilent Technologies Japan, Ltd.
Component Test PGU-Kobe
1-3-2, Murotani, Nishi-ku, Kobe-shi,
Hyogo, 651-2241 Japan

Warranty

This Agilent Technologies instrument product is warranted against defects in material and workmanship for a period of one year from the date of shipment, except that in the case of certain components listed in this manual, the warranty shall be for the specified period. During the warranty period, Agilent Technologies will, at its option, either repair or replace products which prove to be defective.

For warranty service or repair, this product must be returned to a service facility designed by Agilent Technologies. The Buyer shall prepay shipping charges to Agilent Technologies and Agilent Technologies shall pay shipping charges to return the product to the Buyer. However, the Buyer shall pay all shipping charges, duties, and taxes for products returned to Agilent Technologies from another country.

Agilent Technologies warrants that its software and firmware designed by Agilent Technologies for use with an instrument will execute its programming instruction when properly installed on that instrument. Agilent Technologies does not warrant that the operation of the instrument, or software, or firmware will be uninterrupted or error free.

Limitation of Warranty

The foregoing warranty shall not apply to defects resulting from improper or inadequate maintenance by the Buyer, Buyer-supplied software or interfacing, unauthorized modification or misuse, operation outside of the environmental specifications for the product, or improper site preparation or maintenance.

No other warranty is expressed or implied. Agilent Technologies specifically disclaims the implied warranties of merchantability and fitness for a particular purpose.

Certification

The Agilent Technologies certifies that this product met its published specifications at the time of shipment from the factory. Agilent Technologies further certifies that its calibration measurements are traceable to the United States National Institute of Standards and Technology, to the extent allowed by the Institute's calibration facility, or to the calibration facilities of other International Standards Organization members.

Exclusive Remedies

The remedies provided herein are the buyer's sole and exclusive remedies. Agilent Technologies shall not be liable for any direct, indirect, special, incidental, or consequential damages, whether based on contract, tort, or any other legal theory.

Assistance

Product maintenance agreements and other customer assistance agreements are available for Agilent Technologies products.

If you need assistance, contact your nearest Agilent Technologies Sales and Service Office. Addresses are provided at the back of this manual.

Manual Printing History

The manual printing date and part number indicate its current edition. The printing date changes when a new edition is printed. (Minor corrections and updates which are incorporated at reprint do not cause the date to change.) The manual part number changes when extensive technical changes are incorporated.

November 1991 First Edition (part number: 16060-90000)
March 2000 Second Edition (part number: 16060-90000)

Safety Summary

The following general safety precautions must be observed during all phases of operation, service, and repair of this instrument. Failure to comply with these precautions or with specific **WARNINGS** given elsewhere in this manual violates safety standards of design, manufacture, and intended use of the instrument.

The Agilent Technologies assumes no liability for the customer's failure to comply with these requirements.

Do NOT operate in an Explosive Atmosphere

Do *not* operate the instrument in the presence of flammable gasses or fumes. Operation of any electrical instrument in such an environment constitutes a safety hazard.

Keep Away from Live Circuits

Operating personnel must not remove instrument covers. Component replacement and internal adjustments must be made only by qualified maintenance personnel. Do not replace components with the power cable connected. Under certain conditions, dangerous voltages may exist even with the power cable removed. To avoid injury, always disconnect power and discharge circuits before touching them.

Do NOT Service or Adjust While Alone

Do *not* attempt internal service or adjustment unless another person, capable of turning off power and capable of rendering first aid and resuscitation, is present.

Do NOT Substitute Parts or Modify Instrument

Because of the danger of introducing additional hazards, do *not* substitute parts or perform unauthorized modifications to the instrument. Return the instrument to a Agilent Technologies Sales and Service Office for service and repair to ensure the safety features are maintained.

Dangerous Procedure Warnings

Warnings, such as the example below, precede **POTENTIALLY DANGEROUS PROCEDURES** throughout this manual. Instructions contained in the **warnings** must be followed.

Warning



Dangerous voltages, capable of causing death, are present in this instrument. Use extreme caution when handling, testing, and adjusting this instrument.

Safety Symbols

General definitions of safety symbols used on equipment or in manuals.



Instruction manual symbol: the product will be marked with this symbol when it is necessary for the user to refer to the instruction manual in order to protect against damage to the instrument.



Indicates dangerous voltage (terminals fed from the interior by voltage exceeding 1000 volts must be so marked).

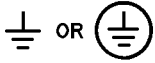

Protective ground terminal. For protection against electrical shock in case of a fault in the instrument. Used with wiring terminals to indicate the terminal which must be connected to ground before operating equipment.



Low-noise or noiseless, clean ground (earth) terminal. Used for a signal common, as well as providing protection against electrical shock in case of a fault in the instrument. A terminal marked with this symbol must be connected to ground in the manner described in the installation (Operation) manual, and before operating the equipment.

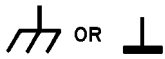

Frame or chassis terminal. A connection to the frame (chassis) of the equipment which normally includes all exposed metal structures.



Alternating current (power line).



Direct current (power line).



Alternating or direct current (power line).

Warning



Warning denotes a hazard. It calls attention to a procedure, practice, condition or the like, which, if not correctly performed or adhered to, could result in *injury* or *death* to personnel.

Caution



Caution sign denotes a hazard. It calls attention to a procedure, practice, condition or the like, which, if not correctly performed or adhered to, could result *damage* to or *destruction* of part or all of the product.

Note



Note denotes important information. It calls attention to a procedure, practice, condition or the like, which is essential to highlight.

Contents

1. General Information	
Introduction	1-1
Using the 16060A	1-1
Product Description	1-1
Accessories Supplied	1-1
Operating And Safety Precautions	1-2
Operating	1-2
Service	1-2
Specifications	1-3
Supplemental Performance Characteristics	1-3
2. Preparation for Use	
Introduction	2-1
Initial Inspection	2-1
Environment Considerations	2-3
Operating and Storage	2-3
Connecting The Test Fixture For Use	2-3
Repackaging the Test Fixture	2-4
3. Operation	
Introduction	3-1
OPEN Correction	3-2
Operation	3-3
How to Connect to Autotransformer	3-4
To Disconnect the Transformer Being Measured	3-4
How to Use the A:B Switch	3-5
How to Extend the Test Leads	3-5
Internal Circuit of the 16060A	3-6
4. Service	
Introduction	4-1
Replaceable Parts	4-1

Figures

2-1. Product Overview	2-2
2-2. Connecting the Test Fixture	2-3
3-1. Test Fixture Features	3-1
3-2. Making an OPEN	3-2
3-3. Connecting a Transformer	3-3
3-4. Connecting an Autotransformer	3-4
3-5. Internal Circuit of the 16060A	3-6

Tables

1-1. Furnished Accessories	1-1
2-1. Contents	2-2
3-1. Relationship Between the A:B Switch Position and Measurement Parameters	3-5
4-1. Replaceable Parts List	4-1

General Information

Introduction

The purpose of this manual is to enable you to use your 16060A Transformer Test Fixture efficiently and confidently. This manual contains both general and specific information. To use the 16060A to perform a specific function (without having to read the entire manual), follow the directions in “Using the 16060A”.

Using the 16060A

- To install the 16060A, turn to Chapter 2.
- To operate the 16060A, turn to Chapter 3.
- To order replaceable parts for the 16060A, turn to “Replaceable Parts” in Chapter 4.

Product Description

The 16060A has been designed to operate specifically with Option 001 “Add N/M/DC-R Measurement Function” of 4263A LCR Meter. The 16060A provides a convenient means of measuring a transformer’s self-inductance, mutual inductance, turns ratio, and dc resistance in the frequency range of dc to 100 kHz, as appropriate for each measurement.

Accessories Supplied

The following accessories are supplied with the 16060A:

Table 1-1. Furnished Accessories

Description	Part Number	Quantity
Operation and Service Manual	P/N 16060-90000	1
Test Leads (black)	P/N 16060-61601	2
Test Leads (red)	P/N 16060-61602	2

Operating And Safety Precautions

Operating

You need observe only normal precautions when handling and operating the 16060A. Do not exceed the operating input power, voltage, and current level and signal type appropriate for the instrument being used, refer to your instrument's operation manual.

Caution



Electrostatic discharge (ESD) can damage the highly sensitive microcircuits in your instrument. ESD damage is most likely to occur when the test fixture is being connected or disconnected. Protect the 16060A from ESD damage by wearing a grounding strap that provides a high resistance path to ground. Alternatively, ground yourself to discharge any static charge build-up by touching the outer shell of any grounded instrument chassis before touching the test port connectors.

Never touch a test port connector's center contact.

Use a work station equipped with an anti-static work surface.

Service

The voltage levels in this fixture do not warrant more than normal caution for operator safety. Nevertheless, service should be performed only by qualified personnel.

Specifications

This section lists the complete 16060A specifications. These specifications are the performance standards and limits against which the 16060A is tested. When shipped from the factory, the 16060A meets the following specifications:

Measurement Parameters	L, N, M, and DCR
Frequency Range	DC to 100 kHz
Applicable Instrument	4263A with Option 001
Weight	300 g
Operating Temperature	0 to 55°C
Operating Humidity	≤95% RH (@40°C)
Non-operating Temperature	-40 to 70 °C
Non-operating Humidity	≤95% RH (@65°C)

Supplemental Performance Characteristics

This section gives supplemental performance characteristics. Supplemental performance characteristics are not specifications, but are typical characteristics included as additional information for the operator. Supplemental performance characteristics are not guaranteed.

Cable Length	25 cm
Dimensions	90 mm (W) × 35 mm (H) × 90 mm (D)
Applicable DUT Size	
Diameter of DUT's terminals.....	4 mm

Preparation for Use

Introduction

This chapter explains how to install the 16060A Transformer Test Fixture. The topics covered include initial inspection, ambient environmental considerations, connecting the test fixture for use, and repackaging the test fixture for shipping.

Initial Inspection

This fixture has been carefully inspected electrically and mechanically before being shipped from the factory. It should be in perfect physical condition, no scratches, dents or the like, and it should be in perfect electrical condition. Verify this by carefully performing an incoming inspection to check the test fixture for signs of physical damage and missing contents. If any discrepancy is found, notify the carrier and Agilent Technologies. Your Agilent Technologies sales office will arrange for repair and replacement without waiting for the claim to be settled.

1. Inspect the shipping container for damage, and keep the shipping materials until the inspection is completed.
2. Verify that the shipping container contains everything shown in Figure 2-1 and listed in Table 2-1.
3. Inspect the exterior of the 16060A for any signs of damage.

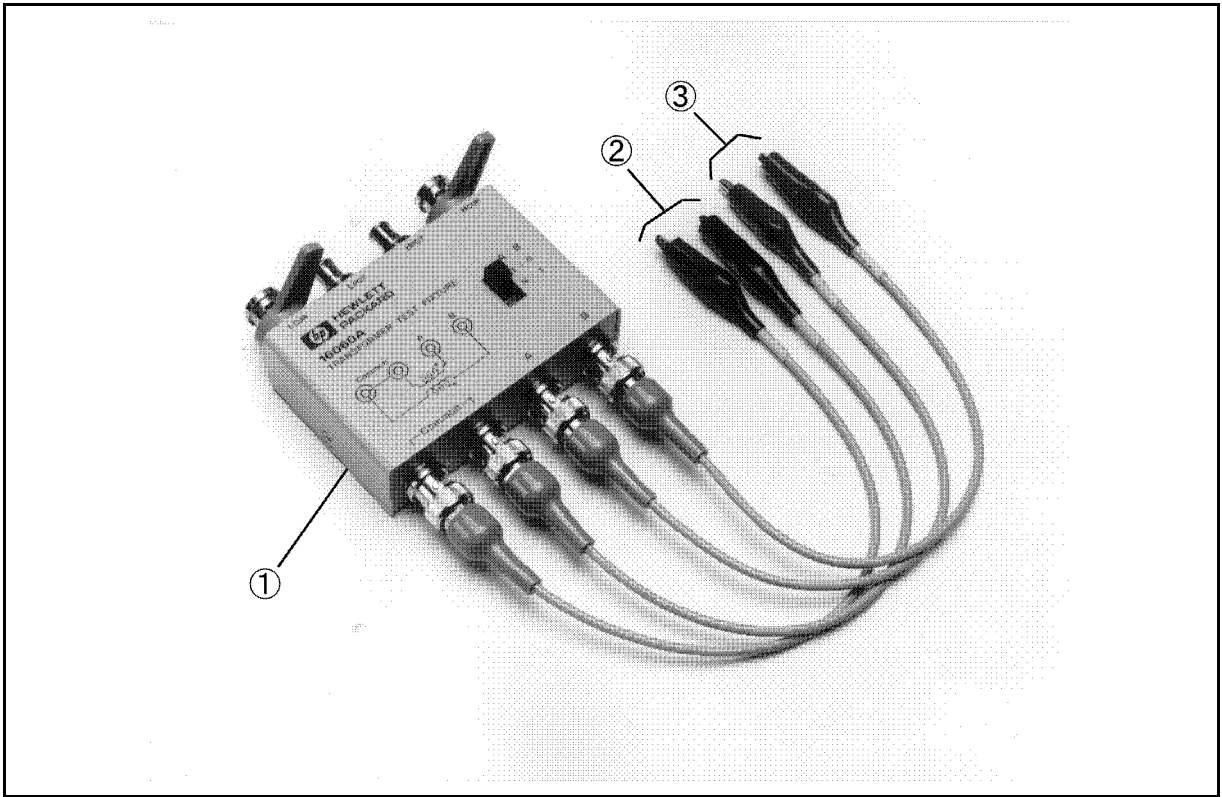

Figure 2-1. Product Overview

Table 2-1. Contents

Description	Agilent Part Number	Quantity
① Transform Test Fixture	16060-60001 ¹	1
② Test Lead (black)	16060-61601	2
③ Test Lead (red)	16060-61602	2
④ Operation and Service Manual ²	16060-90000	1

1 Agilent internal-only part number.

2 Operation and Service Manual is not shown in Figure 2-1.

Environment Considerations

Operating and Storage

The 16060A should be operated within an ambient temperature range of 0°C to 55°C and relative humidity up to 95% at 40°C (non-condensing).

The 16060A may be stored within a temperature range of -40°C to +70°, and at a relative humidity of up to 95% at +65°C (non-condensing).

Connecting The Test Fixture For Use

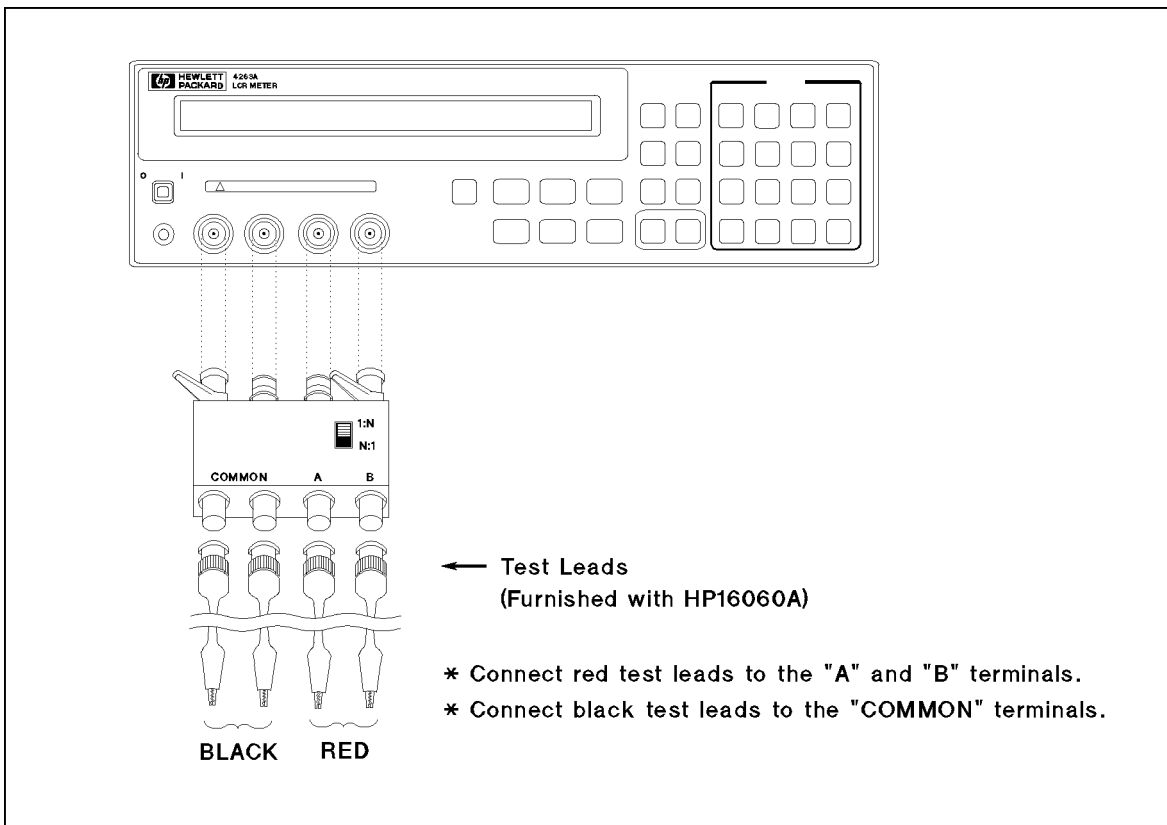

Figure 2-2. Connecting the Test Fixture

Repackaging the Test Fixture

If shipping to a Agilent Technologies service center is required, the test fixture should be repackaged using the original factory packaging materials.

Alternatively, comparable packaging materials may be used. Wrap the test fixture in heavy paper and pack in anti-static plastic packing material. Use sufficient shock absorbing material on all sides of the 16060A to provide a thick, firm cushion and to prevent movement during shipping. Seal the shipping container securely and mark it *FRAGILE*.

Operation

Introduction

This chapter describes the features of the 16060A (Figure 3-1), and describes how to connect a transformer to the test fixture (Figure 3-3 and Figure 3-4), how to set the A:B switch for different measurements, how to physically extend the measurement distance from the 4263A using cables and test leads, and describes the internal circuit of the 16060A.

For instructions on how to measure transformer parameters, see the *4263A Operation Manual*.

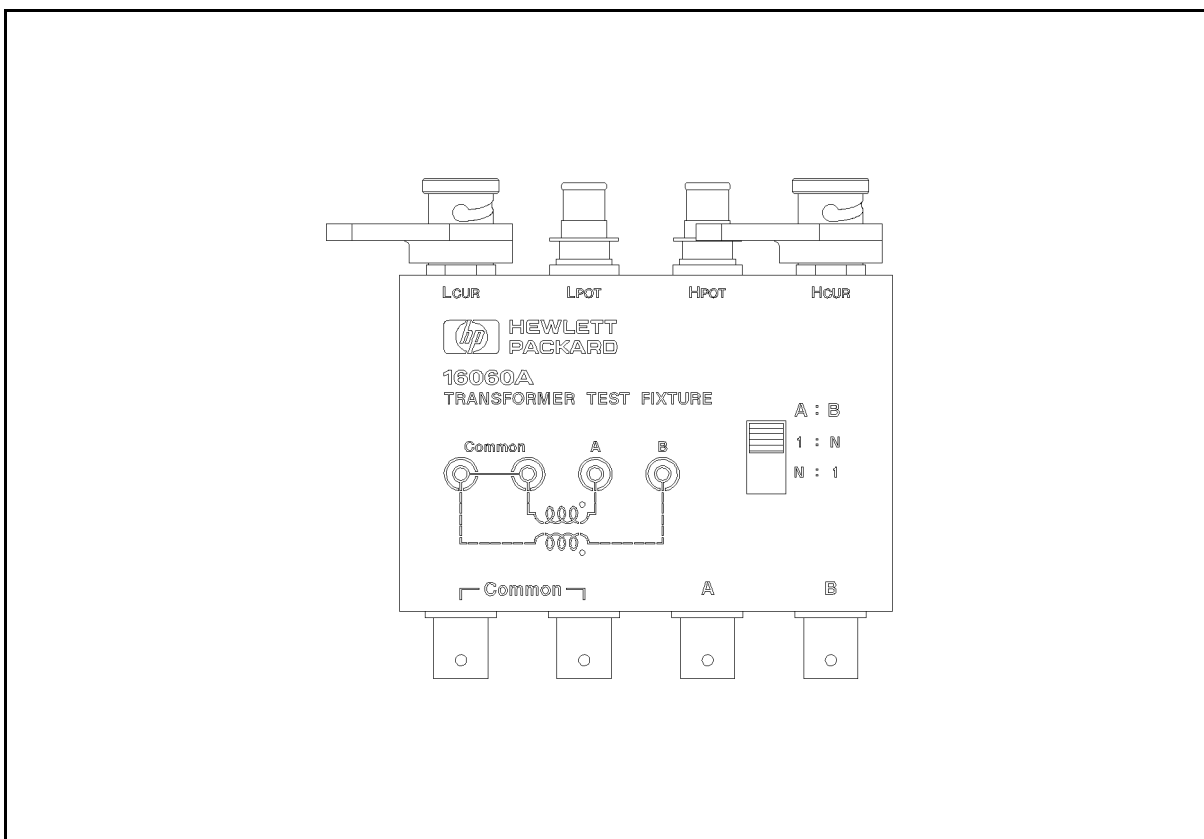

Figure 3-1. Test Fixture Features

1. *Four terminal pair BNC terminals.* These terminals are connected to the UNKNOWN terminals of the 4263A.
2. *A:B Switch.* Switch A:B changes the connection between terminal “A” and terminal “B” to select the transformer parameter to be measured.
3. *COMMON terminals.* These terminals are connected using test leads to the common (low) terminals of the transformer to be measured as shown in Figure 3-3 and Figure 3-4.

4. *A terminal.* Terminal A is connected using a test lead to one of the high terminals of the transformer under test as shown in Figure 3-3 and Figure 3-4.
5. *B terminal.* Terminal B is connected using a test lead to the other high terminal of the transformer under test as shown in Figure 3-3 and Figure 3-4.

OPEN Correction

The 16060A has inherent stray capacitance that adds an error term which decreases measurement accuracy. To cancel these residual effects and thus minimize measurement error, use the measuring instrument's OPEN correction capability. The procedure is described in the instrument's operation manual. To make an OPEN setup for this procedure, connect the center conductors of "A" and "B" together by clipping the respective alligator clips together, and separate them from the likewise connected center conductors of the COMMON terminals. Figure 3-2 illustrates an OPEN connection setup.

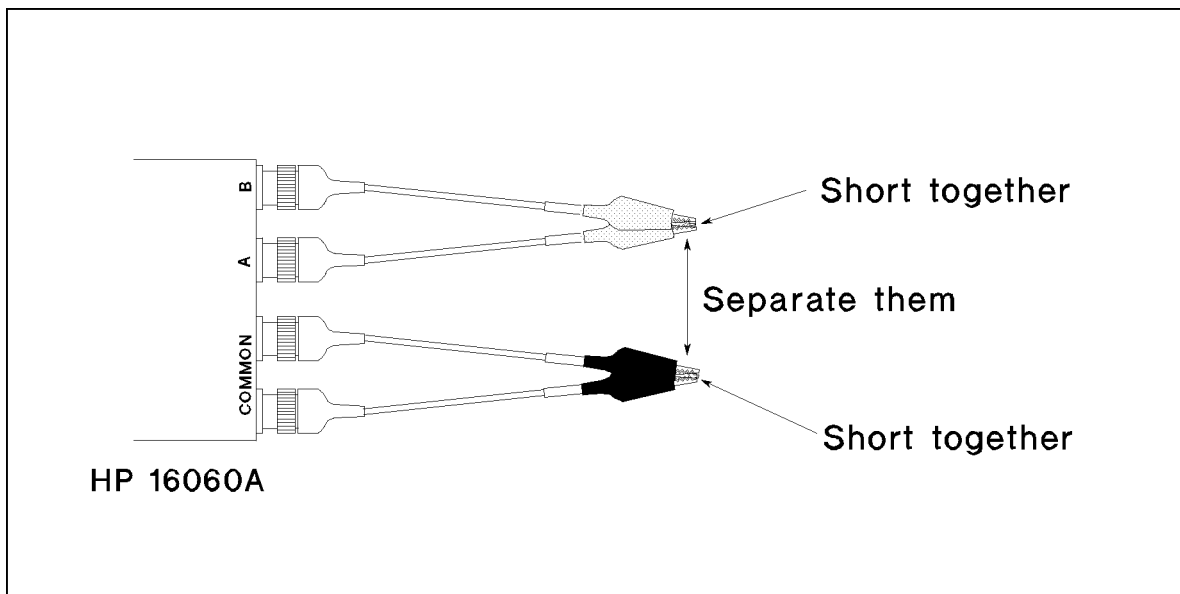

Figure 3-2. Making an OPEN

Note



The effects of the 4263A SHORT correction depend on the measurement parameters. For more information on the SHORT correction function, see the *4263A Operation Manual*.

Operation

1. Connect the 16060A to the UNKNOWN terminals of the 4263A.
2. Connect the furnished BNC test leads to the 16060A.
3. Perform an OPEN correction as described in the *4263A Operation Manual*.
4. Connect the respective alligator clips to the transformer to be measured as follows:
 - a. When switch A:B is set to 1:N, first connect the alligator clips of the *COMMON* terminals and *terminal A* to the transformer before connecting the alligator clip from *terminal B*.
 - b. When switch A:B is set to N:1, first connect the alligator clips of the *COMMON* terminals and *terminal B* to the transformer before connecting the alligator clip from *terminal A*.

Warning



Terminal B is connected to terminal H_{cur} when switch A:B is set to 1:N, or terminal A is connected to terminal H_{cur} when the switch A:B is set to N:1. While terminal H_{cur} of the 4263A is connected to a terminal of the transformer, high-voltage induction may occur at the other terminals. For operator safety, when connecting the transformer, follow the above mentioned connection order.

5. The Figure 3-3 and Figure 3-4 show the connecting a transformer.

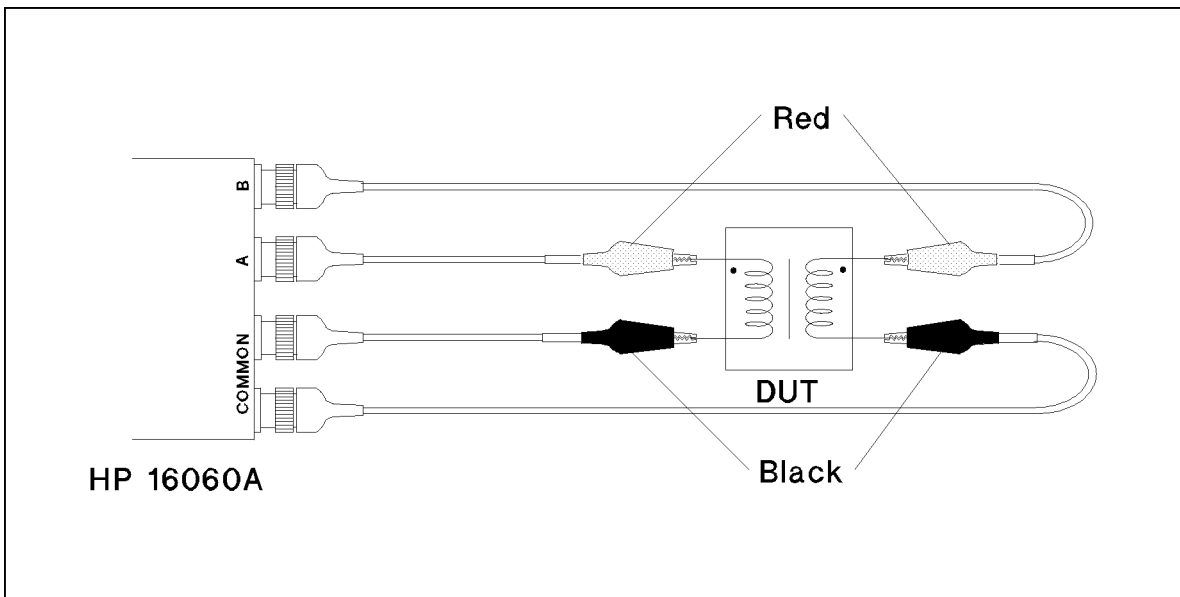

A9403003

Figure 3-3. Connecting a Transformer

Note



When the transformer to be measured has a terminal common to both the transformer's primary and secondary (for example: an autotransformer), connect the COMMON terminals of the 16060A to the common terminal of the transformer, because the COMMON terminals of the 16060A are connected together inside in the 16060A. (See Figure 3-4 and Figure 3-5.)

How to Connect to Autotransformer

When the 16060A is used to measure an autotransformer, connect the test leads as shown in Figure 3-4.

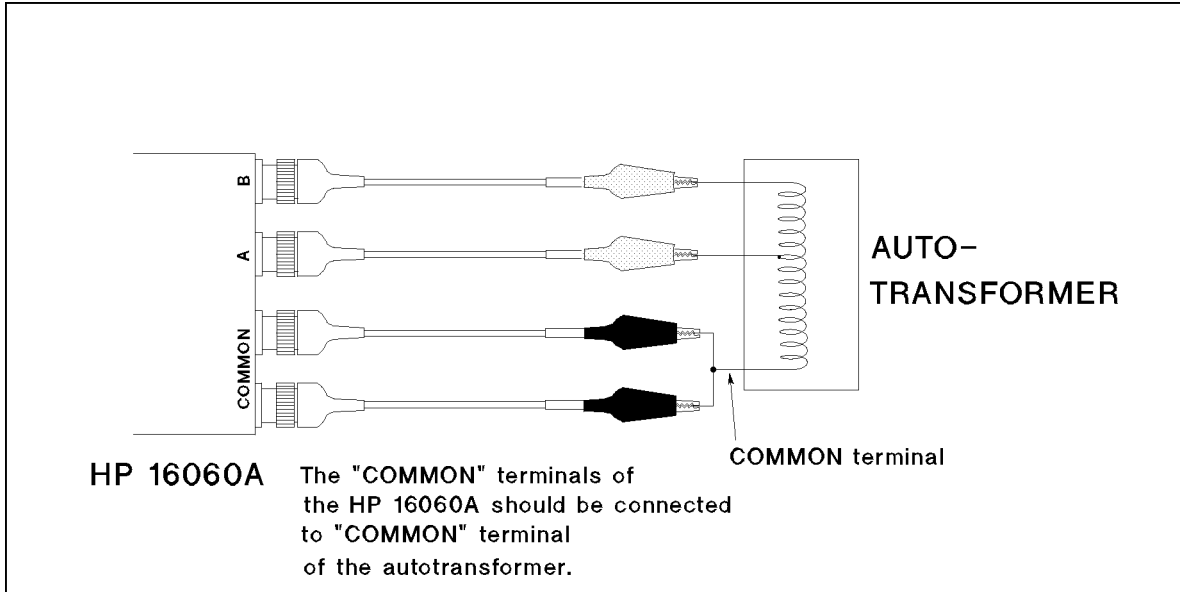

Figure 3-4. Connecting an Autotransformer

To Disconnect the Transformer Being Measured

Warning



Terminal B is connected to terminal H_{cur} when switch A:B is set to 1:N, or terminal A is connected to terminal H_{cur} when the switch A:B is set to N:1. While terminal H_{cur} of the 4263A is connected to a terminal of the transformer, high-voltage induction may occur at the other terminals. For operator safety, when disconnecting the transformer, follow the disconnection order given below:

- When switch A:B is set to 1:N, first disconnect the alligator clip of *terminal B* from the transformer before disconnecting the alligator clips of the *COMMON terminals* and *terminal A*.
- When switch A:B is set to N:1, first disconnect the alligator clip of *terminal B* from the transformer before disconnecting the alligator clips of the *COMMON terminals* and the *terminal B*.

How to Use the A:B Switch

The 4263A can measure self-inductance (L2), DCR (R2), mutual inductance (M), and the turns ratio (N) of a transformer. (the 2 following L and R means these parameters are measured using the two-terminal measurement configuration.)

When the A:B switch is set to “1:N”, the 4263A can measure the L2, R2 parameters of the transformer winding connected to the “B” terminal and the turns ratio N as n_b divided by n_a . (n_a means the number of turns in the transformer winding connected to “A” and n_b means the number of turns in the transformer winding connected to “B”.)

When the A:B switch is set to “N:1”, the 4263A can measure the L2 and R2 parameters of the transformer winding connected to the “A” terminal and the turns ratio N as n_a divided by n_b .

Note



Set the switch to the opposite position if 4263A displays “OVLD” as the measured value of N. The 4263A cannot measure values of N less than 0.9, and “OVLD” means that the measurement result is out of range.

The following table summarizes the relationship between the A:B switch position and the parameters the 4263A measures.

Table 3-1.
Relationship Between the A:B Switch Position and Measurement Parameters

Switch Position	Measurement Parameter			
	L2	R2	N	M
1:N	Self inductance of the transformer winding connected to “B”	DCR of the transformer winding connected to “B”	$n_b / n_a (\geq 0.9)^1$	Mutual inductance
N:1	Self inductance of the transformer winding connected to “A”	DCR of the transformer winding connected to “A”	$n_a / n_b (\geq 0.9)^1$	

¹ n_a is the number of turns in the winding connected to “A”, n_b is the number of turns in the winding connected to “B”.

How to Extend the Test Leads

When you extend the test leads to keep the DUT away from the 4263A, extend the BNC cables between the 16060A and the 4263A and keep the test leads between the 16060A and the transformer being measured as short as possible because the terminal configuration between the 4263A and the 16060A is a four-terminal pair (4TP) configuration and the configuration between the 16060A and the DUT is a two-terminal (2T) configuration. The effect of residuals on a measurement due to extended 4TP configuration test leads is less than that of the effects due to the 2T test lead configuration.

To extend the 4TP configuration, use an 16048A (1 m), 16048D (2 m), or 16048E (4 m) BNC cables. To connect these extension leads and 16060A, four female-female BNC adapters (Agilent part number:1250-0080) are required.

Internal Circuit of the 16060A

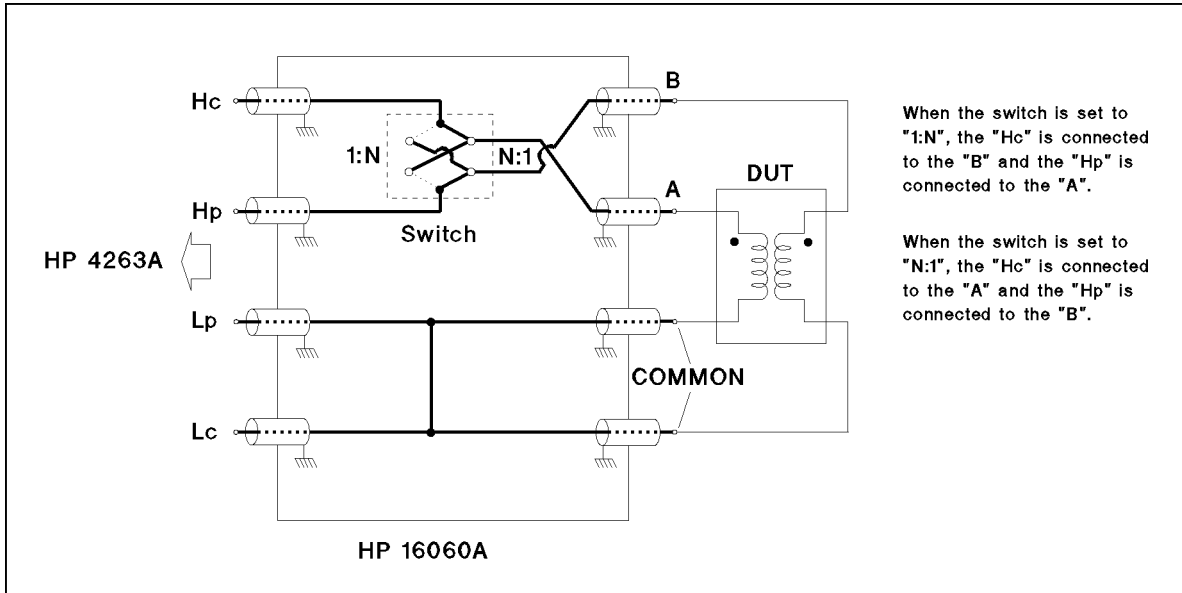

A9403001

Figure 3-5. Internal Circuit of the 16060A

Note



The measurement terminal configuration changes from four-terminal pair to two-terminal on the DUT side of the 16060A (at the point inside the box where the 4TP configuration changes to the 2T configuration). Setting the A:B switch to 1:N connects the H_{cur} terminal to the B terminal and connects the H_{pot} terminal to the A terminal. Setting the A:B switch to N:1 connects the H_{cur} terminal to the A terminal and connects the H_{pot} terminal to the B terminal.

Service

Introduction

This chapter gives Replaceable Parts service information for the 16060A.

Replaceable Parts

Table 4-1 lists the replaceable parts. The parts listed in this table can be ordered from your nearest Agilent Technologies Service office. Ordering information should include the Agilent part number and the quantity required.

Table 4-1. Replaceable Parts List

Part Number	Qty.	Description
16060-04001	1	Chassis Top Cover
16060-04002	1	Chassis
0515-0914	2	Screw Flat Head M3×0.5 L6
16060-66501	1	PC Board ¹
3101-2850	1	Switch Slide
0515-1550	4	Screw Pan Head M3×0.5 L8
1250-0118	4	Connector BNC (f)
1250-1798	2	Connector BNC (m)
16012-7122	2	Connector BNC (m) w/ Lever
2190-0016	8	Washer (for BNC Connector)
2950-0001	8	Nut (for BNC Connector)
16060-61601	2	Cable Assy w/ Black Alligator Clip
16060-61602	2	Cable Assy w/ Red Alligator Clip

¹ Includes Slide Switch

REGIONAL SALES AND SUPPORT OFFICES

For more information about Agilent Technologies test and measurement products, applications, services, and for a current sales office listing, visit our web site: <http://www.agilent.com/find/tmdir>. You can also contact one of the following centers and ask for a test and measurement sales representative. 11/29/99

United States:

Agilent Technologies
Test and Measurement Call Center
P.O.Box 4026
Englewood, CO 80155-4026
(tel) 1 800 452 4844

(fax) (61 3) 9272 0749
(tel) 0 800 738 378 (New Zealand)
(fax) (64 4) 802 6881

Canada:

Agilent Technologies Canada Inc.
5150 Spectrum Way
Mississauga, Ontario
L4W 5G1
(tel) 1 877 894 4414

Asia Pacific:

Agilent Technologies
24/F, Cityplaza One, 1111 King's Road,
Taikoo Shing, Hong Kong
(tel) (852)-3197-7777
(fax) (852)-2506-9284

Europe:

Agilent Technologies
Test & Measurement
European Marketing Organization
P.O.Box 999
1180 AZ Amstelveen
The Netherlands
(tel) (31 20) 547 9999

Japan:

Agilent Technologies Japan Ltd.
Call Center
9-1, Takakura-Cho, Hachioji-Shi,
Tokyo 192-8510, Japan
(tel) (81) 426 56 7832
(fax) (81) 426 56 7840

Latin America:

Agilent Technologies
Latin American Region Headquarters
5200 Blue Lagoon Drive, Suite #950
Miami, Florida 33126
U.S.A.
(tel) (305) 267 4245
(fax) (305) 267 4286

Australia/New Zealand:

Agilent Technologies Australia Pty Ltd
347 Burwood Highway
Forest Hill, Victoria 3131
(tel) 1-800 629 485 (Australia)

This information is subject to change without notice.
© Keysight Technologies 1991, 2000, 2015
Edition 3, February 2015



16060-90000
www.keysight.com